

**Nissin**  
DIGITAL

  
**NASS**  
Ready!

Compatible with  
Nissin Air System

*i60A*

Canon/ Nikon digital SLR cameras

**INSTRUCTION MANUAL**



**NISSIN.JAPAN**

Changes or modifications not expressly approved by the party responsible for compliance could void the user's authority to operate the equipment.

This device complies with Part 15 of the FCC Rules. Operation is subject to the following two conditions: (1) this device may not cause harmful interference, and (2) this device must accept any interference received, including interference that may cause undesired operation.

## Thank you for purchasing a Nissin product

Before using this flash unit, please read this instruction manual and refer your camera owner's manual carefully to get a better understanding of the proper operation to enjoy flash photography.

Nissin i60A type Canon or Nikon are designed for Canon or Nikon cameras, with the latest TTL (Canon camera: ETTL / ETTL II or Nikon camera: i-TTL) flash control system. Please note that i60A are not usable with other branded cameras for TTL operation.

### SPECIAL FEATURES

The i60A is very compact in size, it can still deliver a high power output of 60GN (at ISO 100, 200mm zoom head position). Also, you can connect your i60A to an external power source to reduce the flash recycle time during constant high power output.

Combined with the Color LCD display and selector dial design, the i60A gives the user the most convenient way to take full control of the flash.

The i60A with wireless flash shooting using Nissin Air System/ radio transmission.

Flash protection function:

When the red LED lamp starts blinking, it means that flash is overheating.

The LED turns red when charging.

When the LED lamp turns green, the flash is charged and you can start to shoot.

**Remark:**  Nissin Air System (NAS) is designed for Nissin flash and Nissin commander.

## Compatible cameras

Please refer Nissin's compatibility chart shown at its home page for details and recent updates: <http://www.nissin-japan.com> or <http://www.nissindigital.com>

# SAFETY INSTRUCTIONS

These safety instructions refer to important information on how to use this product safely and properly. Please read the following instructions before using the product.



## WARNING

This symbol refers to the possibility of personal injury, death or property damage if not followed as described.

- The flash unit contains high voltage electric parts. Do not try to open or repair the flash unit. Return it back to the repair service station or the store where you bought it from.
- Do not touch the inside parts from the opening when the unit was dropped or broken.
- Do not shoot the flash directly to the eyes at short distance. It may damage the eyes.
- When taking a flash picture, especially toward a baby, it is recommended to keep the flash unit at least 1 meter (3.3feet) away from the subject. Or use diffuser or bounce the light to the ceiling or wall to soften its intensity.
- Do not place the flash unit near any flammable gas, chemicals or such liquids. It may cause fire or electric shock.
- Do not touch the flash unit with wet hands or use in the water. The flash unit carries high voltage inside and it may cause an electric shock.
- Do not shoot the flash unit directly at the driver of automobiles or such vehicles.
- Do not set the flash window close to the human body and shoot, which may get scalded.
- Place the batteries correctly in position. Placing the batteries in wrong polarity may cause leakage, exothermic heat or explosion.



## CAUTIONS

This sign refers to conditions which may cause damage or defect.

- Do not leave or store the flash unit in the temperature over 40°C/ 104°F, such as in the automobile.
- The flash unit is not water resistance. Keep the unit away from rain, snow and humidity.
- Do not use benzene, thinner or other alcoholic agents to clean the unit.
- Do not use this flash unit with cameras which are not recommended in the compatibility list at official website, otherwise it may damage the camera's circuitry.
- Remove the batteries when not in use for a longer period of time.
- Do not have a heavy impact to the flash unit, nor throw it onto a hard surface floor.

# Names of the Components

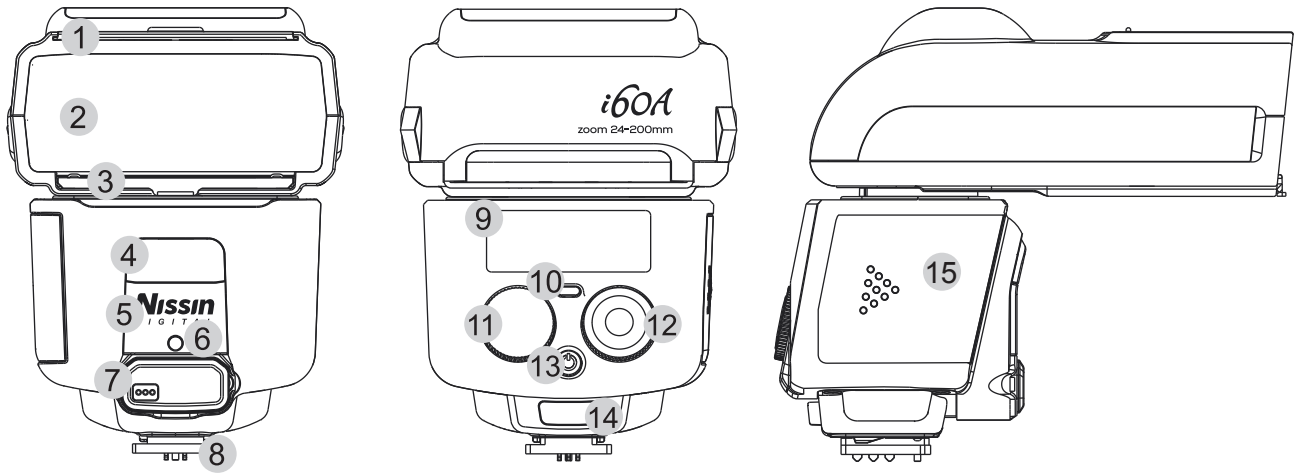

- 1 Fill-in reflector
- 2 Flash head
- 3 Light diffusing panel
- 4 Video light
- 5 Remote/ Slave sensor
- 6 AF-assist light
- 7 Battery pack adapter
- 8 Mounting foot and Hotshoe contacts
- 9 Color monitor
- 10 Pilot button (Test flash button)
- 11 Mode dial
- 12 Control wheel and button
- 13 Power button
- 14 Unlock button
- 15 Battery compartment door

## Accessories:

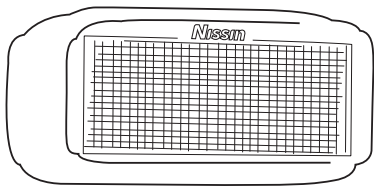

Soft box

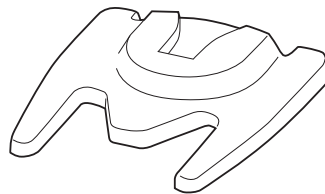

Flash stand

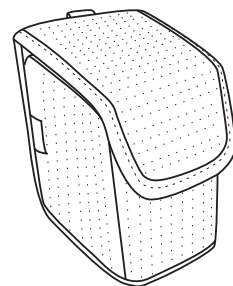

Pouch

# Basic Operation

## Inserting batteries

Usable batteries - Alkaline batteries, Lithium batteries or NiMH batteries.

1. Open the battery compartment door and insert 4 x size AA batteries as shown by the picture.
2. Make sure the + and - battery contacts are correctly inserted at the battery compartment.
3. Close the battery compartment door and slide it back in place.

When the recycle time becomes longer than 30 seconds, replace the batteries with fresh ones or recharge the batteries (rechargeable batteries).

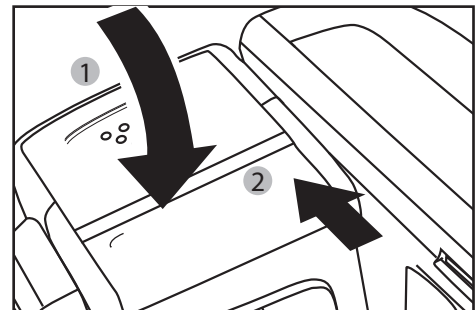
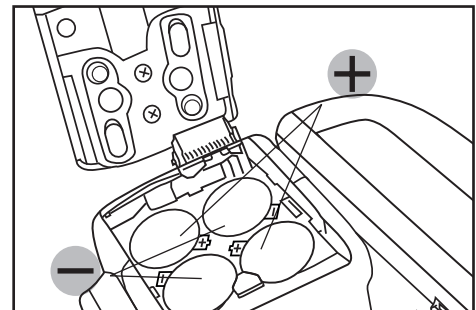
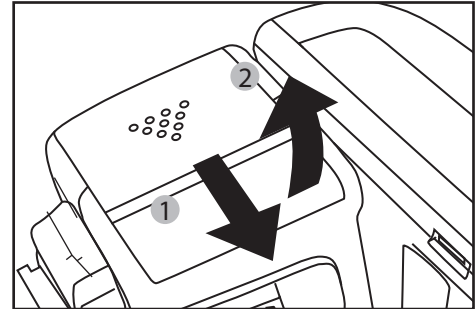

### NOTE

It is recommended to use all 4 batteries of the same brand and type, and replace them all at the same time.

Wrong insertion of each battery would not make electric contact.

## Basic Operation

### i60A has an energy saving power off function

To save battery energy, i60A automatically switches to stand-by mode, in A mode, TTL mode & Manual Power mode, in about 2 minutes of idle use; in SD mode, SF mode & Wireless TTL mode, in about 5 minutes of idle use.

While i60A is in the stand-by mode a Pilot button blinks every 2 seconds showing the flash unit is in stand-by mode. To turn on i60A again, press the camera's shutter button halfway or press any button of the flash unit.

In case i60A is not in use for over 60 minutes, the unit is completely turned off.

To turn on i60A again, take the first step of turning the flash unit on.

### Protect overheating function

i60A is automatically turned off when repeating hi power full flash continuously over 20 to 30 times to protect the flash circuitry from overheating. It will automatically recover after 15 minutes of inactivity. The pilot button will blink in the red color every 1.5 seconds.

## Mounting i60A on the camera

1. Slide the mounting foot of i60A into the hotshoe of the camera.
2. Make sure that the mounting foot will lock (with a “click”) when it has been inserted completely.

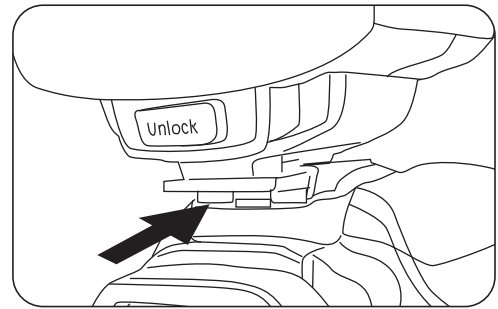

## Removing i60A from the camera

- Press the unlock button and slide the mounting foot of i60A off the hotshoe of the camera.

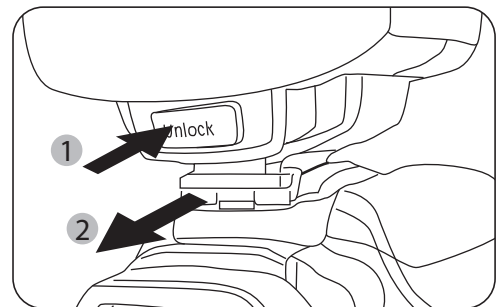

## Turn on the flash unit

- Press the On/ Off switch and Pilot button turns red, showing the unit is turned on.
- In a few seconds, the Pilot button turns green. The i60A is ready to shoot.
- For a test flash, press the Pilot button.
- To turn off the flash unit manually, press the On/Off switch once.



# MENU DIAL

## i60A Flash Mode and Functions

Rotate the dial to select a function.



**Video light**  Built in video light with 9 steps of output level adjustment.

**Full Automatic Mode**  Flash light is fully controlled by the camera for the most proper exposure.

**TTL Program Mode**  Flash light is automatically controlled by the camera but the flash exposure value can be compensated.

**Manual Setting Mode**  Selecting the desired manual power on the flash unit.

**High Speed Synchronization**  Hold the button for 1 sec to activate or deactivate High speed synchronization.  
(Except for Nikon cameras. Nikon users may activate this function in camera menu)

**S<sub>F</sub>** Slave Film

**S<sub>D</sub>** Slave Digital

**Wireless TTL Slave Mode**



**NAS mode**  
**A:** Group A **B:** Group B **C:** Group C

**Optical mode**  
**Canon & Nikon:**  
**A:** Group A **B:** Group B **C:** Group C

**Optical mode will activate automatically when no NAS signal, or 6 seconds after disconnected from other NAS device.**





## Video Light

- Set i60A to the camera's hotshoe and press the on/ off switch to power on.
- Rotate the Function dial to  mode.
- You can select the power by rotating the Power dial, 9 steps of output level can be adjusted .

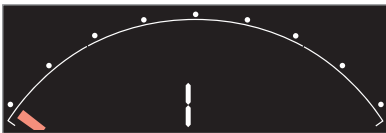
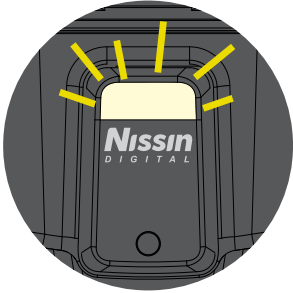

### NOTE

LED video light lighting time approx. 3.5 hours in full power batteries.

## Manual zoom

- Press the on/ off switch to power on.
- Manual Zoom: In TTL, M, SD, SF, Wireless mode
- Hold the Manual zoom button for 1 second to enter the changing mode.
- Turn the outer dial to change the zoom head position.
- Press M.zoom 1 second again to operate the camera.



The zoom setting you selected is memorized and remains unchanged when you restart the flash.

# A

## Shooting i60A automatically

### Canon Carnea

[**P**] (Mode), [□] (Auto), [**Av**] (Aperture Priority)  
[**Tv**] (Shutter Priority), [**M**] (M mode)

### Nikon Carnea

[**P**] (Mode), [  ] (Auto), [**A**] (Aperture Priority)  
[**S**] (Shutter Priority), [**M**] (M mode)

In all of the camera's shooting modes listed above, i60A will fully work in TTL automatic-flash system.

- Set i60A to the camera's hotshoe and press the on/ off switch to power on.
- Indicator Lamp A on.
- Rotate the Function dial to "A" mode.
- i60A is now set for the camera's automatic flash control system.
- Press the shutter button of your camera halfway to focus the subject.
- Shutter speed, aperture and flash mark (  ) are indicated in camera's view finder.
- Take the picture. i60A is fired and the result is immediately shown on the camera's LCD display.
- When you change the focal length, the power zoom flash head of i60A immediately sets its position to match the lens focal length you selected.
- The flash illumination coverage of i60A responds to the lens focal length of 24mm - 200mm.



## Joy of Flash Photography

### TTL flash power compensation

With the latest TTL flash control system, the flash power level is always automatically controlled by the camera for the most appropriate exposure. If you wish, if you can soften or weaken the flash light, or give more light to the subject without changing the environmental or background exposure effect. The i60A can make it possible to quickly adjust the exposure for each particular flash picture as needed.

- Set i60A to the camera's hotshoe and press the on/ off switch to power on.
- Rotate the Function dial to "TTL" mode.
- To set the Flash power compensation level rotate the Control wheel to the power level you desire.
- TTL flash power compensation is provided in 12 steps by 1/3 Ev increments for -2.0, -1.7, -1.3, -1.0, -0.7, -0.3, 0, +0.3, +0.7, +1.0, +1.3, +1.7 and +2.0 Ev.
- Take a picture and the subject is shown with required lighting effect by keeping the background exposure level as originally expected.
- On some cameras, the TTL flash power compensation setting is provided in its menu mode. When setting the TTL flash power compensation on your camera, any compensation which is also set on the i60A will be counted in addition to the compensation you selected in the camera's menu mode. ( i.e. Having a +1 compensation set on the flash and a +1.3 compensation set in the camera would yield a total compensation of +2.3 EV.)

# M

## Manual Exposure Flash

In some occasions, or for special expression, you may need your own flash exposure instead of the automatic controlled exposure. You can set i60A for non-automatic flash mode, and select the desired flash power.

- Set i60A to the camera's hotshoe and press the on/ off switch to power on.
- Rotate the Function dial to "M" mode.
- You can select the power by rotating the Control Wheel :  
1/256 – 1/1 (Full) power.  
Red color bar represent 1 step, White color bar represent 1/3 step

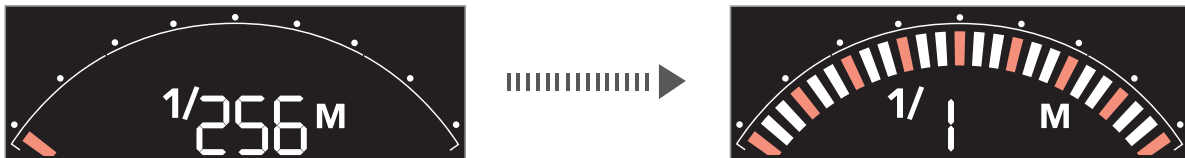

- Set the camera shooting mode to Canon camera is [AV] mode and Nikon camera is [A].or [M]
- Select your desired F--stop and / or shutter speed. Point at the subject and press the shutter.



## Wireless Slave Flash

i60A has a wireless remote flash system as a slave unit. You can enjoy creative flash photography with multiple lightings from the various directions. 2 slave modes are provided, Slave Digital (SD) for digital pre-flash system; Slave Film (SF) for analogue flash system.

**SD:** In this mode, i60A synchronizes to the pre-flash system. The master flash is to be set at TTL mode. Canon camera is E-TTL and Nikon camera is i-TTL.

- You can select the power by rotating the Control wheel from 1/256 – 1/1 (Full) power.
- Press the lock button once to lock this condition on your flash. (Press it again to release the lock)

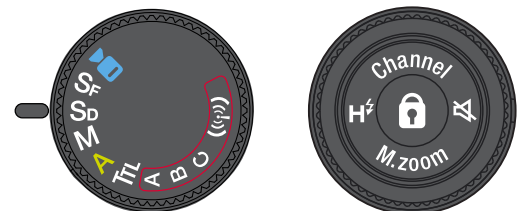

**SF:** In this mode, i60A synchronizes to the traditional single flash system. The master flash is to be set at manual mode. Studio lighting system synchronizes to this mode. This mode is also available for open flash, and for a standard flash in the market.

- You can select the power by rotating the Control wheel from 1/256 – 1/1 (Full) power.
- Press the lock button once to lock this condition on your flash. (Press it again to release the lock)

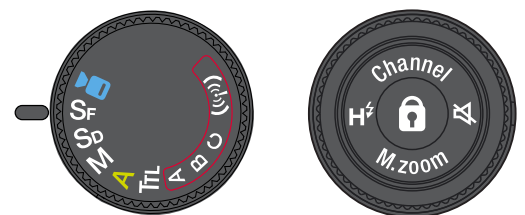

### Wireless Remote - Optical Transmission :

In this mode, i60A synchronizes to the wireless remote flash system. For remote All channels and with groups A=Group A/ B=Group B/ C=Group C digital flash. Canon camera is E-TTL or Nikon camera is i-TTL.

- Rotate the Function dial to “A” “B” “C” mode then AF-assist light blinking.

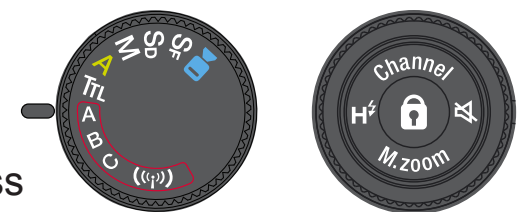

### NOTE

Optical mode will activate automatically when no NAS signal, or 6 seconds after disconnected from other NAS device.



## Wireless Remote Flash

### Wireless Remote - Radio Transmission (NAS)

Using i60A with a NAS shooting function makes it easy to shoot with advanced wireless multiple flash lighting, in the same way as normal TTL autoflash shooting.

Once i60A linked to NAS, function are control directly by the NAS master. User only need to select the group on i60A

- You can select the group by rotating the mode dial

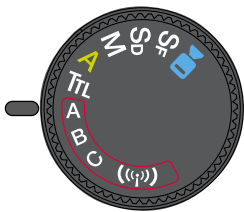

Group A

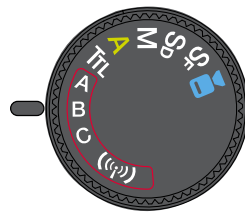

Group B

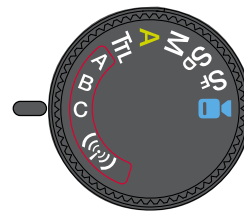

Group C



NAS: TTL mode



NAS: Manual mode

#### NOTE

The Nissin commander attached to the camera is called master unit. i60A will be switched to Radio Transmission Mode (2.4GHz transmission) once connecting to NAS Commander, all functions will be controlled through NAS Commander.

## Shooting the subject

Set the camera for flash shooting mode. Point at the subject and shoot. The slave flash will synchronize to the master flash and gives additional lighting from the different direction you desired.

If the flash unit sleep after 5 minutes of idle, simply press any button on the master flash to wake up the flash unit again. Automatic shut off function is however in effect. It automatically turns-off when not in use for over 60 minutes.

The zoom setting position is automatically set for the focal length of 35mm while using i60A as a slave unit in SD and SF mode.

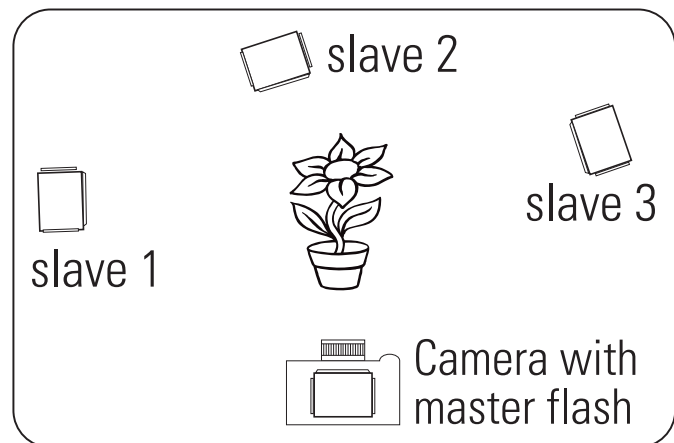

## Fill-in flash and Light diffusing panel and Soft box

For short distance or portrait flash photography, if the light is not too sharp or too strong to the subject, use the fill-in reflector flash or diffuse the light with the supplied soft box.

- If the subject is close (within 2 meters), turn the flash head 90° upward and pull out the fill-in reflector as shown in the picture.
- Take a picture as usual. A blink of fill-in flash freshens up the subject in natural image.
- This small blink of flash is also useful when taking a picture of a baby without scaring him.
- Place the Soft box onto the flash head to soften the light output and reduce the shadows.
- This technology is also useful to eliminate the shadow on the subject under the tree.

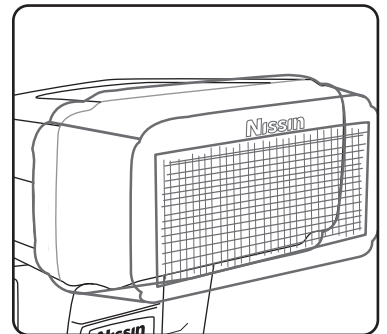
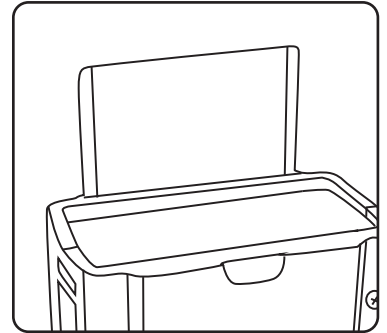

- For portrait photography, pull out the light diffusing panel and place it over the flash window as shown in the picture. The diffusing panel makes the flash light softer.
- Since the light diffusing panel expands the lighting area, it covers the range of 16mm focal length lens.

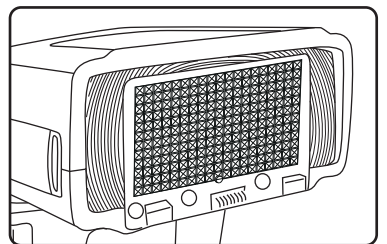



## Bounce lighting

When lighting a subject in front of the wall, an unnecessary sharp shadow may appear on the wall behind the subject resulting in a disappointing picture. Bounce the light off the ceiling or wall to soften the light on the subject, and the shadow will fade.

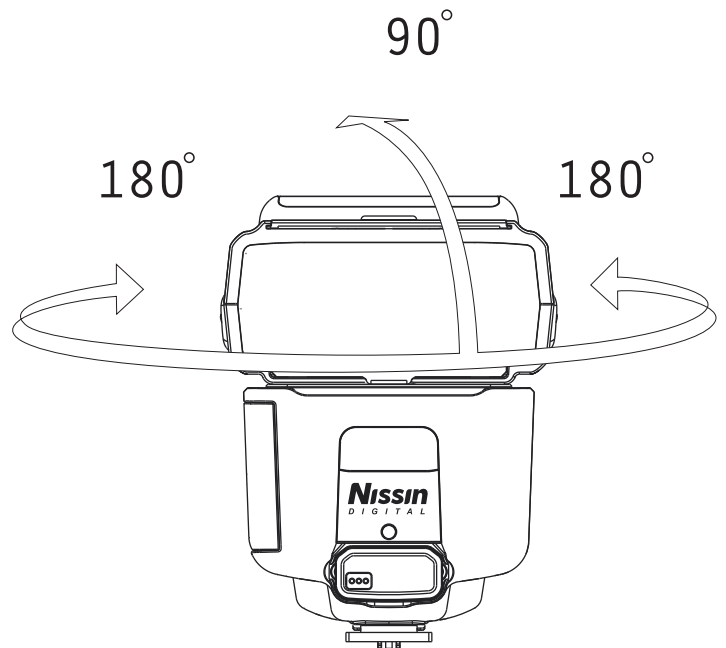

- The flash head turns upward to 45° >60° >75° >90°.
- The flash head sideways to left 30° >60° >90° >120° >150° >180° or to right 30° >60° >90° >120° >150° >180°.
- Or mixing it upward/ sideways, you can set it in multiple directions as shown.
- When the flash head stays at turning or tilting position, the zoom setting position of i60A is automatically set at the position for a 50mm focal length lens.
- The wall or ceiling in this case should be a flat surface and white color is preferable. Colored ceiling or wall may reflect its color on the subject.

## AF assist light emitter

Under a low light condition, or in a dark place, the AF assist light will automatically emit the beam and illuminate the subject, so that the camera can easily focus on the subject in darkness. The beam is however not shown in the picture. AF light will be disable if the camera body has a built-in AF assist light.

## Flash stand usage

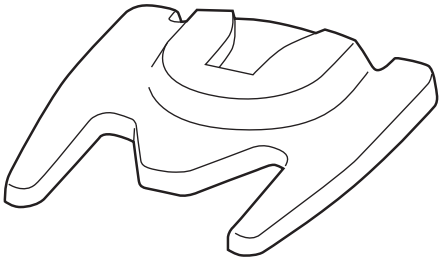

Due to the i60A's compact design and special weight distribution. We strongly recommended user to rotate the flash head in 180 degrees, before doing light bouncing on flat surface with a flash stand.

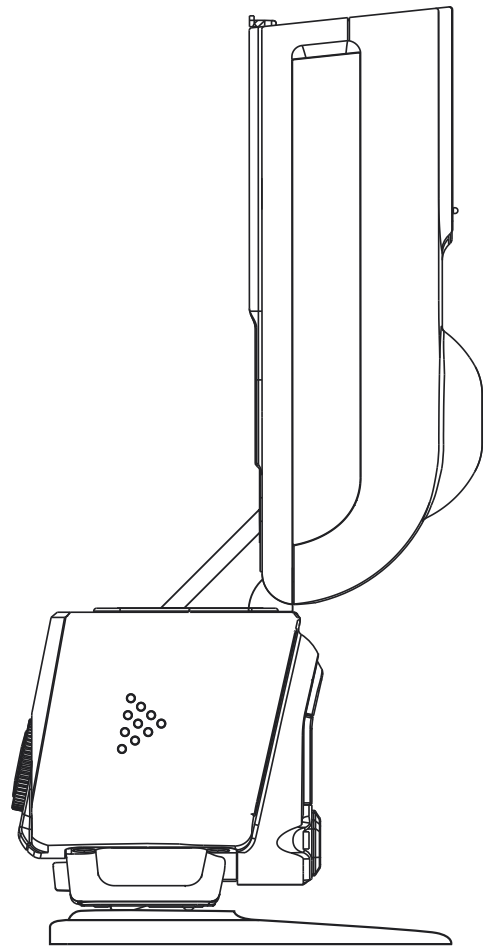
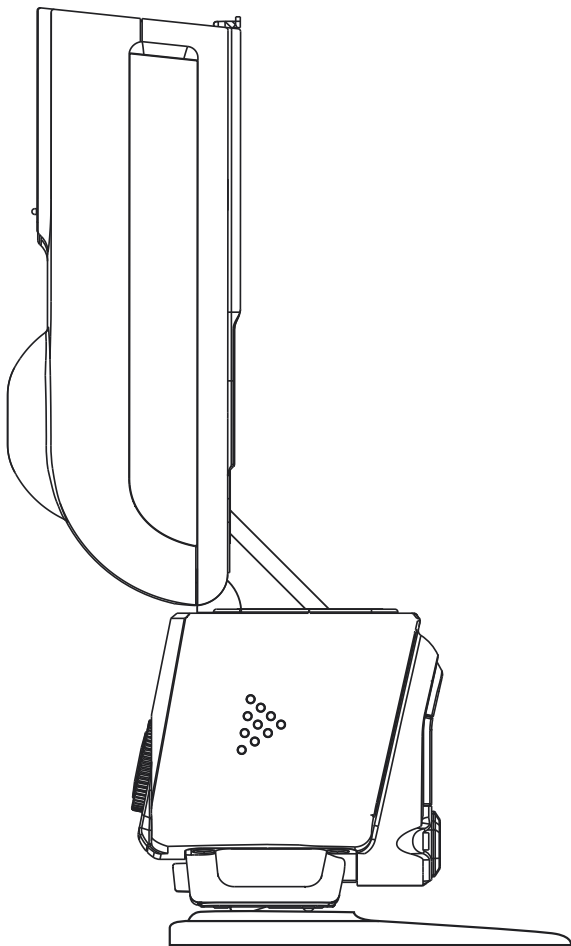

## External Power Pack Socket

When using an external power source, the number of flashes is increased and the recycling time is shortened. The following external power packs are available as an option.

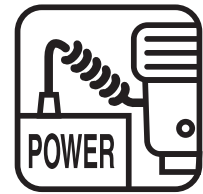

Battery = NiMH battery	Recycle time
Nissin Power Pack PS 8	1.6 seconds
Nissin Power Pack PS300	1.6 seconds
Canon CP-E4	about 3 seconds
Nikon SD-9	about 3 seconds

i60A Fujifilm version uses a Sony version power pack socket. User can purchase an external Nissin power pack PS8 for Sony to enjoy faster recycle time.

i60A is automatically turned off when repeating flash continuously over 20 to 30 times to protect the flash circuitry from overheating. It will automatically recover after 15 minutes of inactivity. The pilot button will blink in the red color every 1.5 seconds.

Please note that the basic operation is controlled by the main batteries(battery magazine) in the flash unit and when the main batteries are exhausted, the flash control system does not work. Replace the batteries when recycle time becomes longer than 30 seconds by main batteries only.

## Flash Power Lock

When the back ground of the main subject is too bright, the camera's exposure reading system adjusts the flash light intensity for such back ground condition and it results in the main subject being underexposed. Or in case the main subject is not placed in the center of the viewfinder, the flash picture may result in the aimed targeted subject being under or over exposed. You can lock the correct flash exposure for the targeted subject in such a condition. This flash exposure pre-set remains locked in, even if you change the aperture or zoom the lens in and out. This mode can only be set on the camera.

### Canon Cameras FE lock

- Focus the subject.
- Aim the viewfinder center over the main subject and press [ ] button on the camera (or [ FEL ] button on some cameras).
- Pre-flash is fired to pre-set the correct light amount for the main subject.  
Remarks: FEL only works on P, TV, AV, M & A-Dep mode.

(It depends on different type of camera, please check you camera instruction manual.)

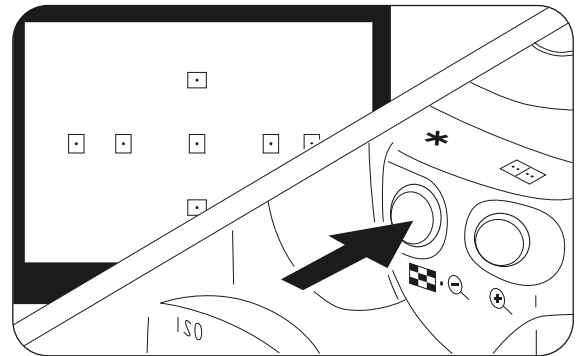

### Nikon Cameras Fv lock

- Set the Fv lock mode at the menu on your camera.
- Focus the subject.
- Aim the viewfinder center over the main subject and press [ AE-L ] button on the camera (or [ AF-L ] button on some cameras).
- Set the picture frame as you desire and release the shutter.

(It depends on different type of camera, please check you camera instruction manual.)

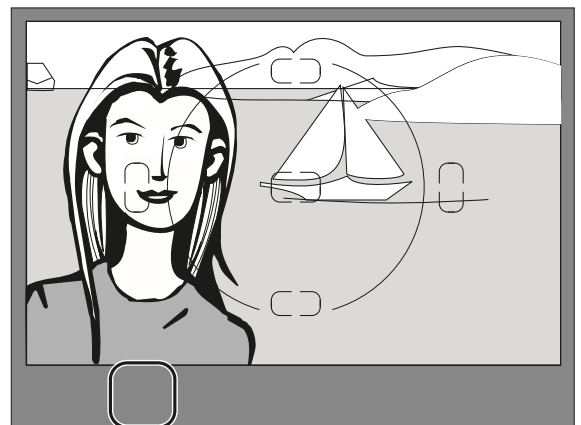

## Specifications

Type	For Canon and Nikon Digital SLR cameras
Guide no. (at ISO 100 in m)	GN60 (at 200mm zoom head position) GN27 (at 24mm zoom head position)
Focal length coverage	24mm – 200mm (16mm when using built-in diffuser)
Power Source	Four size- AA batteries
Battery storage	Directly insert into the body
Recycling Time	0.1- 5.5 seconds
Number of flashes (Approx.)	220- 1500 flashes (2000mAh rechargeable battery)
LED video light lighting time (Approx.)	3.5hrs (full power batteries)
Flash duration	1/800 - 1/20,000 Sec
Color Temperature	5,600k
Exposure control	TTL
Wireless Mode	Wireless TTL Slave: Optical Transmission and Radio transmission (NAS). Non-TTL Slave (SD mode and SF mode)
EV compensation on flash	+/- 2EV in increments of 1/3 of EV
Bounce position	Up: 0-90°, Down: 0°, Left: 180°, Right 180°
Flash exposure control	1st Curtain synchronization, FE & FV Lock (Set on Canon), 2nd Curtain synchronization(Canon) High Speed synchronization, Slow synchronization(Nikon) Red-eye reduction & Rear curtain synchronization(Nikon)
AF-assist beam effective range	0.7 – 5m
Operation panel	Color LCD with dial control
Manual mode power ratio	1/256- 1/1 with 1/3 step selection
Video light	Built in video light with 9 steps output level adjustment
Mode	Auto, Manual, SD, SF, Wireless with A, B, C & channel selection (2.4Ghz Nissin Air system)
External power pack socket	Nissin power pack & Sony's original factory power pack
Accessories	Soft case, flash stand (with screw), Soft box
Dimensions	112(H) x 73(W)x 98(D)mm/4.4(H)x 2.9(W)x 3.6(D) inches
Weight	300g/ 10.8oz (without batteries and soft box)

## Guide Number table

Guide No. at manual exposure mode (ISO 100 in meters)

Zooming Position	Flash Power Level								
	Full	1/2	1/4	1/8	1/16	1/32	1/64	1/128	1/256
24mm	27	19	13	10	7	5	3	2	2
28mm	29	20	14	10	7	5	4	3	2
35mm	32	23	16	11	8	6	4	3	2
50mm	39	28	20	14	10	7	5	3	2
70mm	42	30	21	15	11	7	5	4	3
85mm	45	32	23	16	11	8	6	4	3
105mm	50	36	25	18	13	9	6	4	3
135mm	54	38	27	19	13	10	7	5	3
200mm	60	42	30	21	15	11	7	5	4

## Trouble Shooting

### **The flash unit does not start charging.**

- Batteries are not correctly installed  
>>> Install batteries to correct direction.
- Batteries are exhausted  
>>> Replace the batteries if the recycle time is beyond 30 seconds.

### **The flash unit does not fire.**

- The flash unit is not firmly clipped on the camera  
>>> Mount the flash unit firmly on the camera's hot shoe.
- The flash unit is automatically powered off  
>>> Turn on the switch again.

### **The flash picture is overexposed or underexposed.**

- The unit is set for manual exposure mode  
>>> Set to TTL mode or other power level.

## Warranty

In case of the following reason of the defect, it may void the warranty. Please refer the respective warranty condition for details which depends on the country of purchase.

1. The product is not used in accordance with the instruction of the owner's manual.
2. The product is repaired or modified by the one who is not an authorized repair service.
3. When the product is used with the cameras not applicable, lens, adaptors or such accessories produced by the third party.
4. Fault or defect caused by fire, earthquake, flood, public pollution and such natural accident.
5. In case that the product is stored in dust, moisture, extremely high temperature or such poor condition.
6. Scratch, blemish, crush or worn out by a violent use or treatment.
7. Guarantee card without name of place purchased or date of purchase stamped, or no guarantee card.

***Nissin***

Nissin Japan Ltd., Tokyo  
<http://www.nissin-japan.com>

Nissin Marketing Ltd., Hong Kong  
<http://www.nissindigital.com>



Set the camera's shooting mode, select focal length and take pictures with i60A on your camera.

i60A is a supplement to help you in taking a creative and live picture. Almost all tasks are automatically done by the camera and you just control the camera only.

Mode		Shutter Speed	Aperture Setting	Control on the camera
Canon	Nikon			
[ □ ]	[  ]	Automatic	Automatic	Automatic
[ P ]	[ P ]	Automatic	Automatic	Automatic
[ Tv ]	[ S ]	Manual	Automatic	Any available shutter speed can be set
[ Av ]	[ A ]	Automatic	Manual	Any available f-stop can be set
[ M ]	[ M ]	Manual	Manual	Any shutter speed / f-stop combination can be set

## For Nikon version only

Following functions are available on Nikon cameras.  
Refer to camera owner's manual for details.

- **Slow shutter synchronization**

The flash is controlled at a slow shutter speed to the correct exposure for both the main subject and back ground in low light conditions or at night.

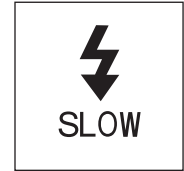

- **Red-eye reduction**

To prevent the subject's eyes from appearing red, i60A fires three controlled flashes just before the picture is taken. Red-eye reduction can be combined with slow sync.

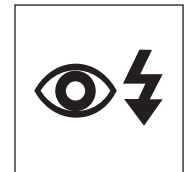

- **Rear curtain synchronization**

In rear-curtain sync., the flash fires just before the rear curtain closes. By using this function at slow shutter speeds, a moving subject will appear with such moving marks behind.